

1



**Attention**

Before any maintenance switch off the main power.

## 2 Cutting Hole

Models:	Low Depth 7W (LD7)	Standard 6.2W / 12.2W / 18W (ST6), (ST12), (ST18)	Narrow Beam 6W / 8W (NB6), (NB8)	Zoom 6.4W / 13W (ZM6), (ZM13)	Warm Dimming 0.2-6W / 12W (WD6), (WD12)	Tunable White 5.9W / 11.5W (TW6), (TW12)
				<b>Note:</b> Zoom should be adjusted before final installation		

**SOUL**

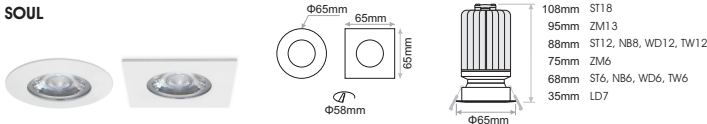

**SOUL DEEP**

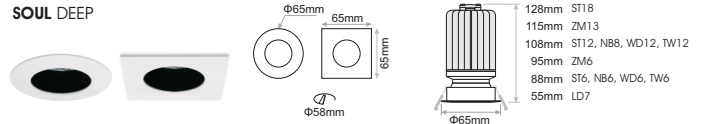

**SOUL ADJ**

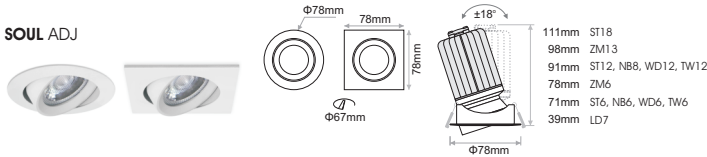

**SOUL ADJ DEEP**

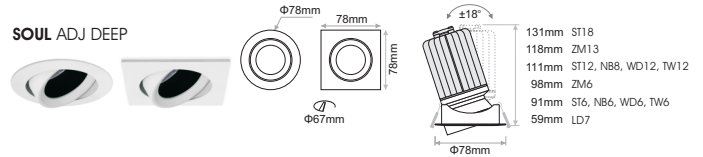

**SOUL IP65**

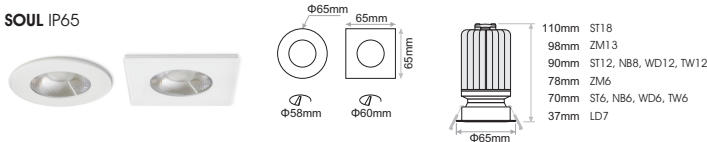

**SOUL IP65 DEEP**

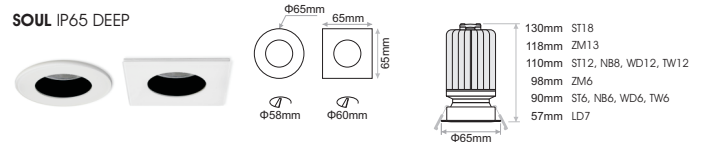

Φ58mm (SOUL, SOUL DEEP, SOUL IP65, SOUL IP65 DEEP)  
Φ67mm (SOUL ADJ, SOUL ADJ DEEP)

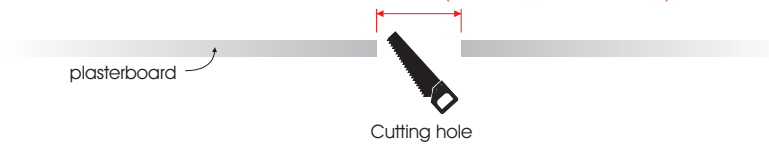

3

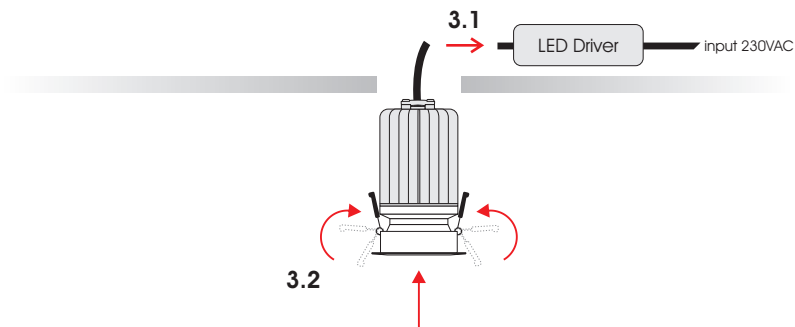

4

